

Parallel LED Circuits

by erkrystof - Thursday, August 05, 2010

<http://www.hoverandsmile.com/parallel-led-circuits/>

Parallel LED Circuits

Keep in mind...

A single series circuit has limits

Remember your LED calculators from the last article!

- [LED Wizard](#)
- [LED Calculator](#)
- [HB LED Calc](#)

If you can only light so many in series, how do you add more LEDs?

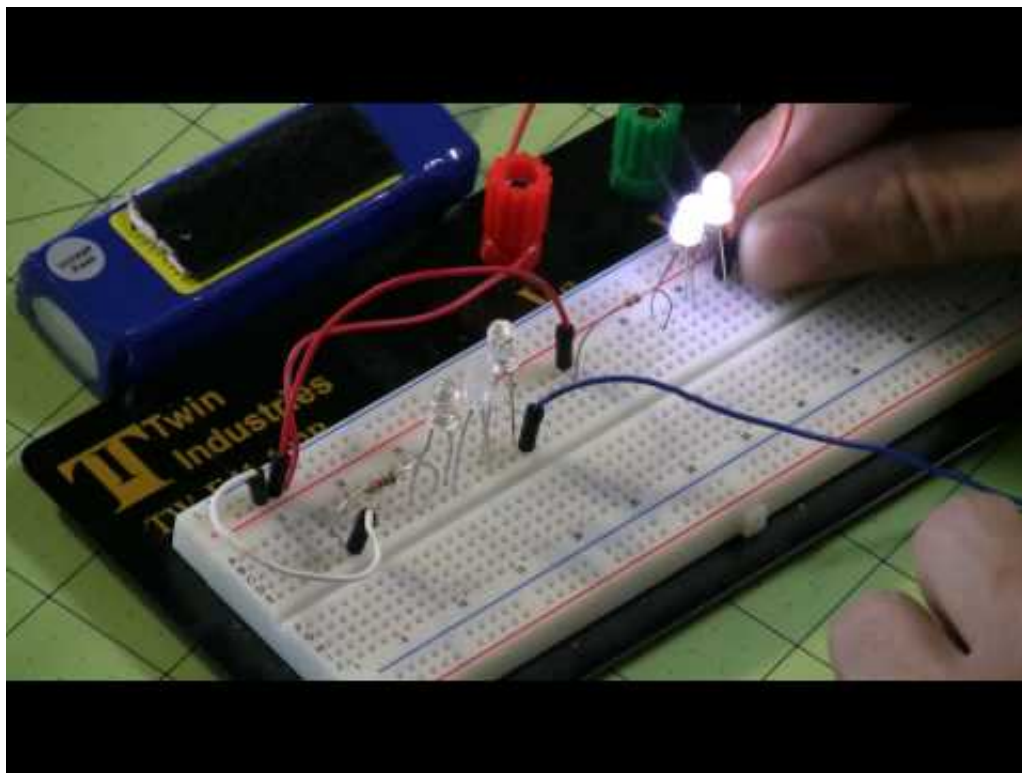

You can wire them in parallel. Parallel means that instead of wiring LED to LED, each LED or small group of LEDs gets its own 'line' from the power source. You can combine this idea to make parallel



wiring of LEDs in series to get past the forward voltage issue. In that case, you could use two resistors for two LEDs per parallel line, but the wiring is just a little different. You could also use three LEDs on one parallel line and a single LED on a separate line. The point being – you have to keep the summation of your forward voltage of all LEDs in series on any ‘line’ less than your supply voltage, then add resistors accordingly. If you don’t, you’ll be right back in the same boat of having too many LEDs in one line and they won’t light up.

Parallel lines give you the same voltage as a single line did, but it does add to the total current drawn through your circuit. It gives real flexibility though, take a look at the following three pictures from the LED Wizard referenced above and see that you can wire 5 LEDs in at least three different ways!

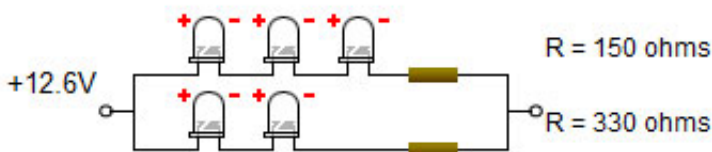
Solution 0: 3 x 1 array, 2 extra LEDs



The wizard says: In solution 0:



- each 150 ohm resistor dissipates 60 mW
- the wizard thinks 1/4W resistors are fine for your application 
- the 330 ohm resistor dissipates 132 mW
- the wizard thinks 1/4W resistors are fine for your application 
- together, all resistors dissipate 192 mW
- together, the diodes dissipate 330 mW
- total power dissipated by the array is 522 mW
- the array draws current of 40 mA from the source.

Different ways to light 5 LEDs

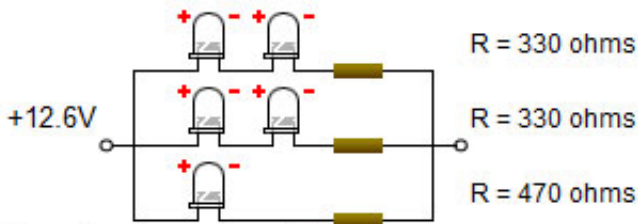
Solution 1: 2 x 2 array, 1 extra LED



The wizard says: In solution 1:

- each 330 ohm resistor dissipates 132 mW
- the wizard thinks 1/4W resistors are fine for your application 
- the 470 ohm resistor dissipates 188 mW
- the wizard thinks 1/2W resistors are needed for your application 
- together, all resistors dissipate 452 mW
- together, the diodes dissipate 330 mW
- total power dissipated by the array is 782 mW
- the array draws current of 60 mA from the source.

Different ways to light 5 LEDs

Solution 2: 1 x 5 array uses 5 LEDs exactly

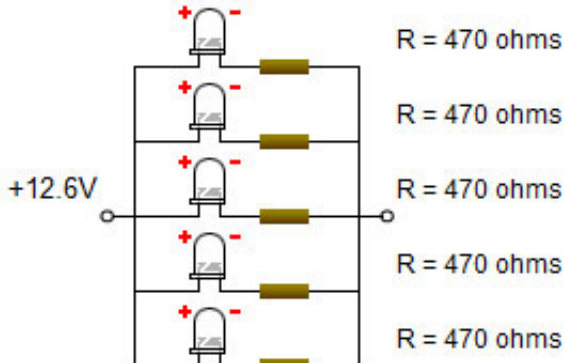

The wizard says: In solution 2:

- each 470 ohm resistor dissipates 188 mW
- the wizard thinks 1/2W resistors are needed for your application 
- together, all resistors dissipate 940 mW
- together, the diodes dissipate 330 mW
- total power dissipated by the array is 1270 mW
- the array draws current of 100 mA from the source.

Different ways to light 5 LEDs

Each of the above circuits work, but they're not exactly the same. Look at the total current used for each

circuit. The 5 LED circuit takes 100 milliamps, but the 2 line circuit only takes 40! The circuit is most efficient when you wire as many as you can in series, so I would actually wire up the first circuit if possible. It may not always be that way though based on your wiring and where you're placing the LEDs, so you'll have to consider that when planning your circuit.

Each time you add a parallel line, you add current through your circuit. You must make sure your battery can support that current. That's where ammeters and multi-meters come in handy (later on in the series we'll hook one up)

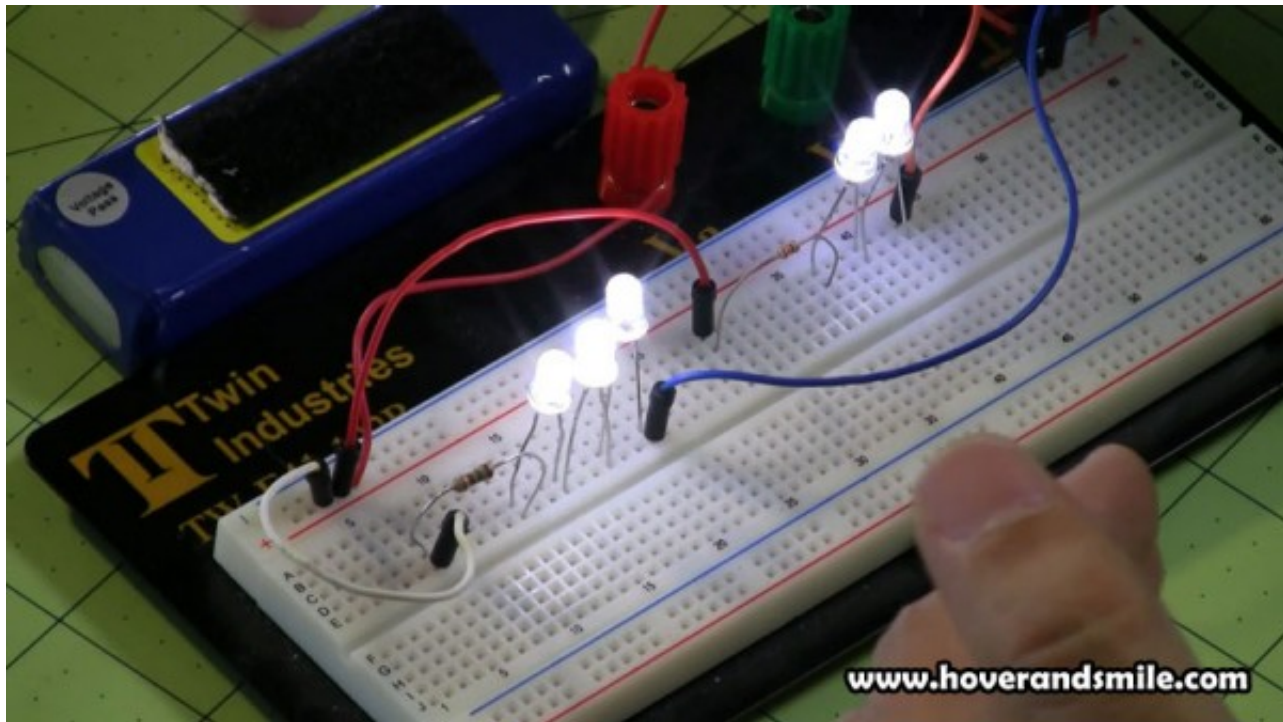

A practical example of circuit #1 wired up – 3 in series and 2 in series, each of those two ‘lines’ wired in parallel.

Wiring in parallel just means you have to split the positive lines and negative lines into multiple wires. Look at the diagrams and you can see we're splitting the positive and negative ends to wire multiple series circuits together.

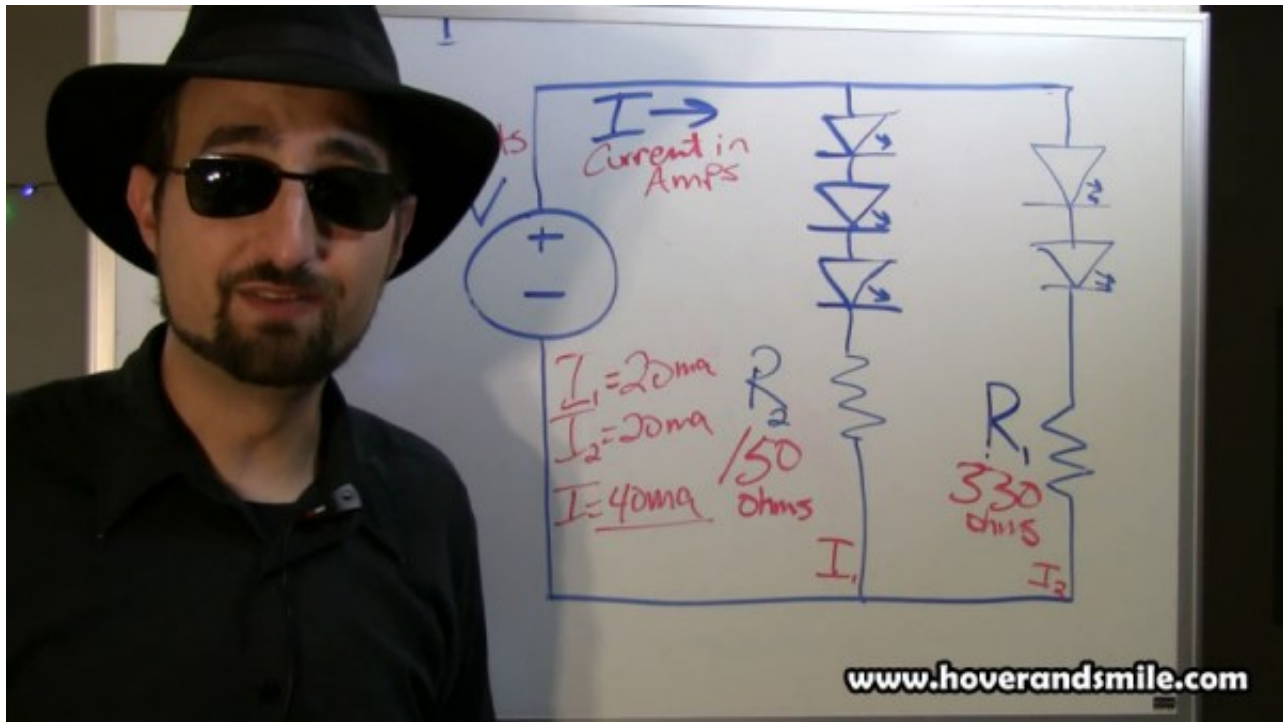

Vinnie shows off his artistic parallel wiring skills. He also paints beautiful stick figure portraits.

But what if you have two LEDs that take two different forward voltages? Best to wire common LED groups in parallel, which allows the current in each parallel line to be adjusted with different resistors for each LED's requirements. You certainly don't have to, but it helps keep resistors at the proper value for the different LEDs.

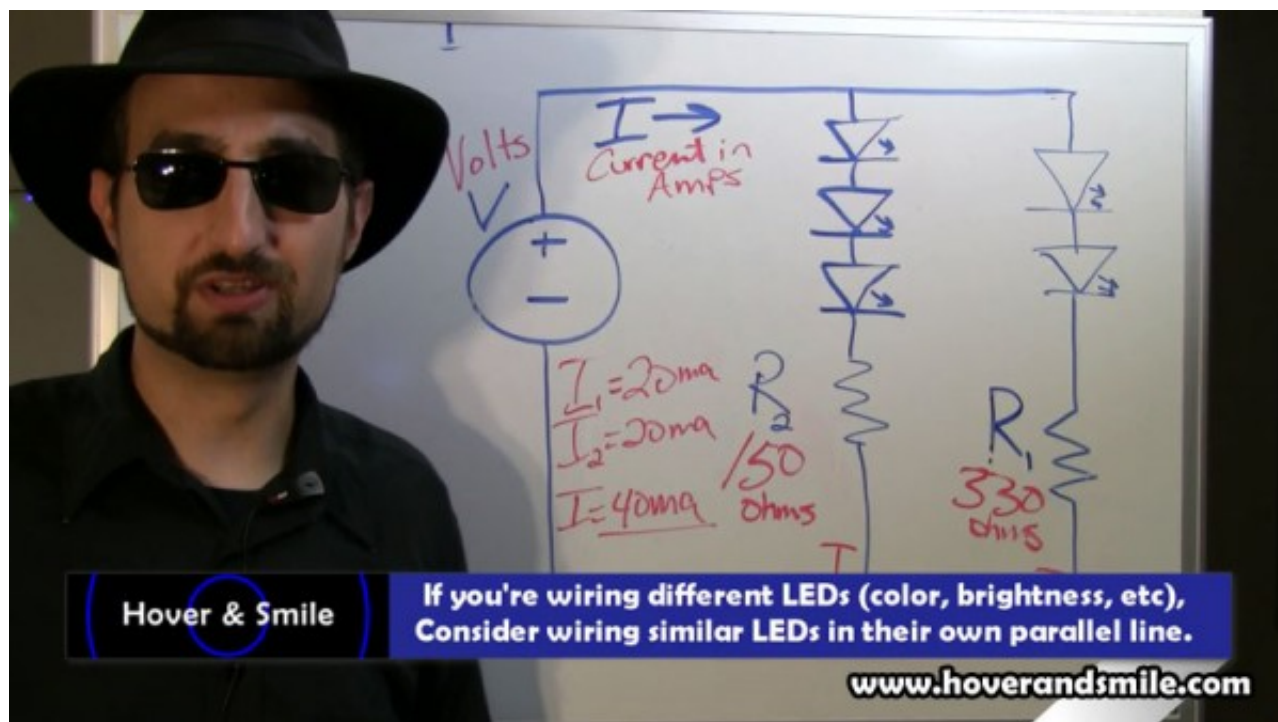

More Parallel Wiring

Don't know the LED voltage or current?

What if you don't know the values of the LED you're using? Well, you're on your own, and you could easily blow out the LED, but here are some general guidelines of values you can try in the LED calculators. Red and Green LEDs typically require less forward voltage than whites and blues, so try 2 to 2.5 volts. Whites and Blues can be targeted for around 3 – 4 volts. 20ma is a decent starter value for the current, which is measured in milliamps (.02 amps).

Comments? (0)

Tags for this article: [electronic-circuits](#), [LED](#), [night flying](#)

PDF source - www.hoverandsmile.com